

# Plumbing Fittings

Trade Guide and  
Technical Manual

**RWC**



**CUT.  
PUSH.  
DONE.**



 1800 810 803

 1800 062 669

 [sales.au@rwc.com](mailto:sales.au@rwc.com)

 [sharkbite.com.au](http://sharkbite.com.au)

AN RWC BRAND  
**RWC**

Reliance Worldwide Corporation (Aust.) Pty. Ltd.  
27-28 Chapman Place, Eagle Farm QLD 4009,  
Australia | ABN 71 004 784 301

## Introduction

Terms and Conditions / Pricing	1
Reliance Worldwide Corporation Warranty	1

## About SharkBite

System Description	2
System Benefits	2
Plumbing System Comparison	2
The SharkBite Design	3
Materials	3
Cross-Linked Polyethylene	3
SharkBite PEX Pipe	4
Precautions	4
PEX Dimensions	4
The Benefits of SharkBite	5

## System Data

Approved Applications	6
Potable Water Approved AS/NZS 4020	6
Environment	6
Water Quality and Chlorine	6
Acoustic Tests	7
UV Resistance	8
SharkBite Burial	8
RWC Silicone Burial Wrap	8
Uncontrolled Heat Sources	8
Disinfection of Plumbing System	9
Installation Considerations	9
Minimum Cold Bending Radii	9
Pipe Clipping	10
Timber Frames	10
Steel Frames	10
Pipes In Chases, Ducts or Conduits	10
Under Concrete Slabs	11
Thermal Properties	11
Thermal Expansion	11
Thermal Insulation	12
Operating Parameters – Pressure & Temperature	12
Fitting Pressure Loss	13
Pressure or Head Loss Through PEX Pipe	13
Maximum Flow Rates	14
Pipe Flow Characteristics	14

## How it Works

SharkBite Push-To-Connect Plumbing System	15
Connection of PEX Fittings	16
Connection of Copper Fittings	17
Disconnecting Fittings	18
Installation Trouble Shooting	19
Installation Best Practice	19
Ineffective Joints	20

## PEX Plumbing System

F1 Straight Coupling	22
F1 Reducing Coupling	22
F2 Straight Connector	22
F3 Straight Connector	22
F12 Elbow	23
F13 Elbow	23
F14 Elbow	23
F15BP Female Lugged Elbow	23
F19BP Male Lugged Elbow	23
Top-Plated Male Elbow	24
F24 Tee	24
F25 Unequal Tee	24
F26 Unequal Tee	24
F27 Unequal Tee	24
F61 Stop End	25
F62 Straight Tap Connector	25
F63 Bent Tap Connector	25
Copper / PEX Braising Tail	25
Capillary / PEX Braising Tail	25
PEX Flare Compression Adaptor	26
Recess Assembly – Lugged	26
Shower Assembly – Lugged (Without Riser)	26
Manifolds	26
DR Ball Valve PEX Connections	27
DR Ball Valve PEX Connection / Female	27



## Push-To-Connect Copper Fittings

No.1 Straight Coupling	28
No.1R Reducing Coupling	28
Slip Coupling	28
No.2 Straight Connector	28
No.3 Straight Connector	28
No. 12 Elbow	29
No. 15BP Female Lugged Elbow	29
No. 19BP Male Lugged Elbow	29
Hot Water Elbow	29
No. 24 Tees	29
No. 25 Unequal Tee	30
No. 61 Stop Ends	30
DR Ball Valves Copper Connections	31
DR Ball Valves Copper Connection / Female	31
DR Ball Valves Copper Connections / Male	31

## PEX Pipe

PEX Pipe – Potable Water (Mustard)	32
PEX Pipe – Hot Water (Red)	32
PEX Pipe – Recycled Water (Lilac)	32
PEX Pipe – Rainwater (Green)	32
100m Coils Mustard Pipe	32
PEX Pipe – Pre-fitted with Conduit For In-Slab Installation	33
Pre-Insulated PEX Pipe	33

## Tempering Valves

Tempering Valves PEX Connections	34
Tempering Valves Copper Connections	34
4 in 1 Tempering Valves – DOWN	34
4 in 1 Tempering Valves – UP	34

## Conversion Fittings

F1 Conversion Couplings SDR9 PEX – Cu	35
F1 Conversion Couplings SDR9 PEX – SDR7.4 PEX	35
F1 Conversion Couplings SDR9 PEX – PB	35
F1 Conversion Couplings SDR9 PEX – SDR9 PEX Auspex / Other	35
F24 Conversion Tee SDR9 PEX – Cu	35
F24 Conversion Tee SDR9 PEX – SDR7.4 PEX	35
F24 Conversion Tee SDR9 PEX – PB	36
F12 Conversion Elbow SDR9 PEX	36

## Tools and Accessories

Tube Cutter	37
Disassembly Clip	37
Depth Gauge / Deburring Tool	37
Tube Bend Support	37
Bare Conduit for UV Protection	37
PEX Pipe – Tube Chasing Sleeve	38
PEX Pipe – RWC Silicone Burial Wrap	38
Pipe De-Coiler	38
Tube Clip	38



## Terms and Conditions

No party should rely upon the contents of this publication as to the fitness of any particular product for any particular use or application. Goods are offered with the benefit of the manufacturers Warranty. Reliance Worldwide Corporation (AUST.) Pty Ltd. shall not be liable for any loss or damage either direct or consequential arising from any defect.

RWC reserves the right to modify designs and specifications and to withdraw and introduce products at any time without notice.

No part of this publication may be reproduced, copied or transmitted in any form by any means graphic, electronic or mechanical (including photo-copying, recording, taping or by any information storage and retrieval system) without prior permission in writing of the publisher Reliance Worldwide Corporation (Aust.) Pty. Ltd.

## Installation

Installation is subject to the requirements of the applicable regulatory authority, the National Construction Code Volume Three – Plumbing Code of Australia, associated reference standards as applicable at the time and AS/NZS 3500. This product is compliant to the Lead Free requirements of the National Construction Code Volume Three. For further Scope of Use, please visit [www.rmc.com.au](http://www.rmc.com.au)

## Reliance Worldwide Corporation Warranty

Reliance Worldwide Corporation (Aust.) Pty. Ltd. (RWC) will either replace or repair any defective goods where the defect arose as a result of manufacture for up to twenty-five (25) years (see website for more details). You may contact RWC at the phone number, address or e-mail shown and will be required to return the goods for evaluation. Should the defect be found to be one of our manufacture we will send you a replacement product to your stated address at our expense. Our goods come with guarantees that cannot be excluded under Australian Consumer Law. You are entitled to a replacement or refund for a major failure and for compensation for any other reasonably foreseeable loss or damage. You are also entitled to have the goods repaired or replaced if the goods fail to be of acceptable quality and failure does not amount to a major failure.

® = Registered Trade Mark of Reliance Worldwide Corporation

© 2024 All rights reserved

## System Description

SharkBite is an advanced design push-to-connect plumbing system for potable and non-potable recycled water distribution. SharkBite is available in an assortment of over 200 fittings and PEX pipe ranging from 16-25mm size. SharkBite has been engineered with ease of use and disconnection in mind and while being the most dependable way to join copper and PEX Pipe in any combination – with no soldering, clamps, unions or glue.

## System Benefits

- Instant push-to-connect connection. Cut. Push. Done.
- No soldering, clamps, unions or glue required
- No expensive joining tools or ongoing tool maintenance
- Reduces installation time with no tightening of nuts, clamps and unions
- Integral tube liner for PEX installations means no loose components and ensures a secure, reliable connection
- The position of the O-Ring and grab ring allow for the immediate detection of leaks
- Can be installed wet or dry
- Rotatable during installation
- Approved for behind the wall and underground application
- Removable after installation
- Clean, professional installation
- Quality engineered and manufactured in Australia
- Compact, robust DZR brass body is strong, corrosion resistant and durable
- SharkBite PEX Pipe is pre-gauged with 'Safe-Seal Indicator Markings' to aid correct installation
- Fittings supplied ready for installation
- Transition fittings to Cu, SDR7.4 PEX, other SDR9 PEX & PB
- No product waste; simply disconnect and reuse

## Plumbing System Comparison

Feature	Push-To-Connect SharkBite	Crimp	Expansion
No tools required	✓	✗	✗
No calibration/maintenance required for proper function of the tool	✓	✗	✗
No grooves in the tubing caused by the expansion tool that can create potential leak paths	✓	✓	✗
No potential for leaks caused by nicks on the fitting exterior	✓	✗	✗
Fitting manufactured in Australia	✓	✗	✗
Easy install with minimal learning curve for new labourers	✓	✗	✗
Reusable during installation – no wasted products	✓	✗	✗
Fitting factory assembled, ready to install from the bag	✓	✓	✗



## The SharkBite Design

The SharkBite Fitting incorporates a number of unique and patented features.

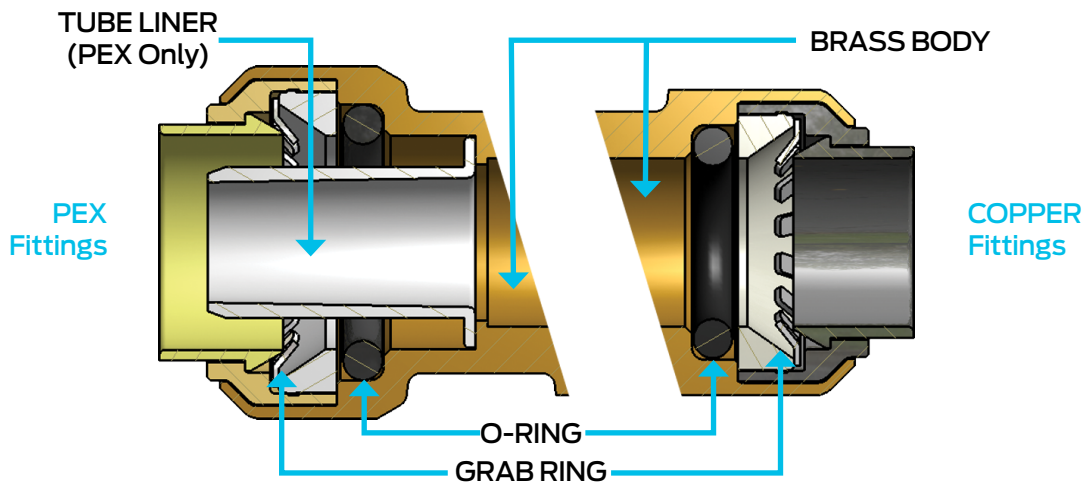

## Materials

<b>Body</b>	LF DZR Brass
<b>Grab Ring</b>	316 Stainless Steel
<b>O-Ring</b>	EPDM
<b>Tube Liner</b>	Polysulfone (PEX fittings only)

SharkBite push-to-connect (PTC) fittings are made from lead free dezincification resistant brass (LF DZR) compliant with the low lead requirements specified in NSF/ANSI/CAN 372. Products are available in 200+ configurations including Couplings, Elbows, Tees, Reducers, Threaded Adaptors, Caps, Breeches, Ball Valves, Tempering Valves and Copper Slip Repair Couplings plus Conversion Couplings and Tees to Cu, SDR7.4 PEX, other SDR9 PEX and PB.

All SharkBite PEX fittings come with a pre-installed tube liner. It is an AS/NZS 3500 requirement when using Push-To-Connect fittings on PEX pipe. Tube liners are not required on copper fittings.

## Cross-Linked Polyethylene

SharkBite Crosslinked Polyethylene is extruded as a PEXb pipe and manufactured using the silane or 'moisture cure' method and is made in a two stage simple process.

1. Silane grafted polyethylene is combined with a catalyst and extruded into PEXb pipe.
2. The cross linking process is then performed by exposing the pipe to steam.

The moisture cure process of cross linking PEXb pipe enhances pipe performance properties including strength, temperature, chemical resistance, crack, creep and abrasion resistance, pipe flexibility, pressure rating, expansion and contraction.

Additionally SharkBite Crosslinked Polyethylene is made using a PEX100 raw material which provides the benefits of an SDR9 pipe wall, improved flow rates, and a pressure rating equivalent to a SDR7.4 pipe.

## SharkBite PEX Pipe

SharkBite PEX pipe is an SDR9 PEXb pipe available in sizes 16, 20 and 25mm in coils and straights with over 30 variations from 5m lengths to 100m coils, in a variety of different colour codes according to AS 2492 and the relevant applications.



### Mustard Pipe

Mustard Pipe is typically used for Potable Water but can also be used for hot water installations.



### Red Pipe

Red Pipe is for hot water application only.

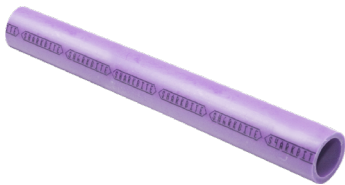

### Purple Pipe

Purple Pipe is coloured and branded specifically for Recycled Water applications in accordance with the authorities' requirements for the distribution of water not suitable for human consumption. This water is generally used for watering gardens and supply to cisterns.



### Green Pipe

Green Pipe is available for rainwater applications.

## Precautions

### Chemicals

Always check with RWC before using SharkBite PEX pipe for applications other than for potable water. Additionally, check with RWC if pipework is to be installed in a known contaminated area, in contaminated soils or where chemical spills may have occurred.

### Electrical

It is of the utmost importance that if a metallic pipe is being replaced or installed in part or in its entirety by a plastic pipe or other non-metallic fittings or couplings, the requirements of AS/NZS 3500 must be followed. Additionally, copper tube connected to a SharkBite fitting does not guarantee electrical continuity. No work should be carried out until the earth requirements have been checked by an electrical contractor and modified if necessary.

## PEX Dimensions

NOMINAL OUTSIDE DIAMETER	16.0	20.0	25.0
Average wall thickness	2.15	2.45	3.00
Average internal diameter	11.7	15.2	19.1



### AUSTRALIAN MADE AND OWNED



SharkBite® fittings and pipe are manufactured in Australia in Reliance Worldwide Corporation (Aust.) Pty. Ltd. state of the art facilities. Stringent quality control and advanced manufacturing procedures guarantee product satisfaction.

### 25 YEAR WARRANTY



The SharkBite® range of fittings and PEX pipe can be relied upon to perform year after year. SharkBite® is backed by the Reliance Worldwide Corporation (Aust.) Pty. Ltd. 25 year warranty.<sup>1</sup>

### VERSATILE AND REUSABLE

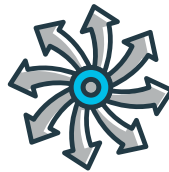

Can be easily disconnected using the SharkBite® Disassembly Clipss. Fittings can be rotated once installed allowing for a more versatile, easier use, especially in confined spaces. This feature is particularly useful where repairs and or maintenance are required.

### QUICK AND EASY



SharkBite® is quick and easy to install, making it the most time effective plumbing system available, allowing the installer to move onto the next job faster than ever before.

Utilising state of the art push-to-connect system design, SharkBite® fittings and pipes are easily assembled by hand.

### STANDARDS APPROVED



SharkBite® fittings and PEX pipe comply with and are approved to Australian Standards AS/NZS 2537 and AS 2492 – 1994 respectively.

## Approved Applications

The SharkBite system has WaterMark certification to AS/NZS 2537 & AS 2492 product standard for use in potable water. SharkBite plumbing systems are approved for hot and cold potable water installations above and below ground.

Please consult with local codes for final approval. Failure to comply with the above types of pipe applications could result in connection failures.

### REFERENCES

- A. AS/NZS 4020 – Testing of products for use in contact with drinking water.
- B. AS 2492 – Cross-linked polyethylene (PEX) pipes for pressure applications.
- C. AS/NZS 2537 – Mechanical jointing fittings for use with cross-linked polyethylene (PEX) pipe for hot and cold water applications.
- D. AS 3688 – Water supply – metallic fittings and connectors.
- E. AS 1432 – Copper tubes for plumbing, gas fittings and drainage applications.
- F. AS 2345 – Dezincification resistance of copper alloys.
- G. AS/NZS 3500 – National plumbing and drainage.
- H. NSF/ANSI/CAN 372 - Drinking Water System Components - Lead Content

## Potable Water Approved AS/NZS 4020

AS/NZS 4020 prescribes tests for analysing the suitability of products for use in contact with drinking water, with regard to their effect on the quality of the water. It is a requirement of Watermark Certification.

## Environment

We recognise that environmental impacts are increasingly important to our stakeholders and to society more broadly. RWC actively manages its consumption of energy, water and raw materials for manufacturing and packaging to mitigate our impact on the environment.

RWC supports local and global efforts to combat climate change and strives for a sustainable low carbon future. Our efforts are aligned with the UNFCCC Paris agreement which is focused on reducing emissions to limit global warming to a 1.5°C increase from pre-industrial level.

## Water Quality and Chlorine

Potable water is sourced using a variety of methods. The Australian Drinking Water Guidelines provides a framework to govern potable water. To achieve this, chlorine and other agents are sometimes used as constituents of the water or for commission purposes.

The SharkBite plumbing system is compliant and certified to AS/NZS 2537 and AS 2492 and as such all components of the system have been certified to AS/NZS 4020. RWC can confirm, based on the AS/NZS 4020 certification that the SharkBite system does not cause any multiplication of micro-organisms, microbial contamination, or legionella growth.

RWC recommend that an independently accredited provider is engaged to undertake any chemical flush of the system and that this work is carried out in line with the relevant Standards. Chemical flushing is to be done in line with the Australian Drinking Water Guidelines that prohibits flushing potable plumbing systems with a solution greater than 5ppm of chlorine and within the normal operating temperatures and pressures as specified in the SharkBite Technical Literature. If chemical flushing with a high concentration solution of chlorine is conducted incorrectly it will have a detrimental effect on any piping system. Dosing must be done in such a way as not to exceed the 5ppm chlorine level in any part of the plumbing system.



## Acoustic Tests

### Results Summary

- The noise emitted by the pipes through the wall was mainly evident in the mid to high frequencies of the A-weighted spectrum.
- Noise emitted at frequencies below 250Hz was affected by the level of background noise in the room.
- The change in radiated noise level was greater with the change in water flow compared with the change in water pressure.
- In all cases the overall noise level emitted by the SharkBite pipe was less than for the copper pipe. For the same flow conditions the differences in overall noise level between the pipes was between 14 and 17dB(A).

### Conclusion

Measurements of noise emitted from nominal 15mm bore pipes attached to the other side of a concrete block wall with water flowing through them and a noise source in the pipe showed that the SharkBite cross-linked polyethylene pipe was between 14 and 17dB(A) quieter than the standard copper pipe.

WATERFLOW (l/min)	WATER PRESSURE (kPa)	MEASURED NOISE LEVEL dB(A)		DIFFERENCE dB(A)
		SHARKBITE	COPPER	COPPER - SHARKBITE
15	300	38	55	17
15	600	40	54	14
20	600	45	62	17
20	700	45	62	17

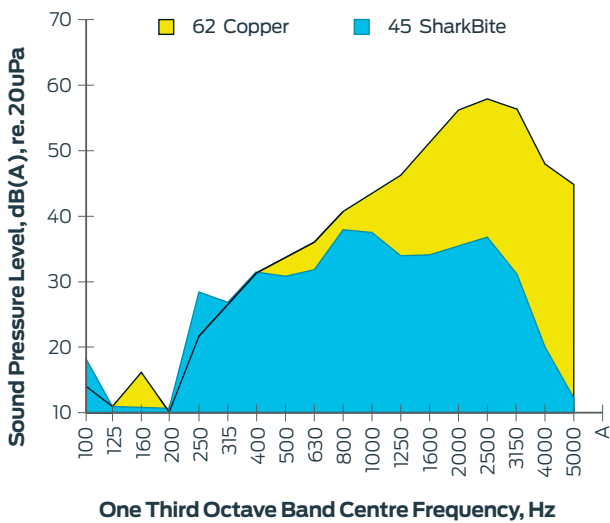

Measured noise level of water flow through nominal 15mm bore SharkBite and copper pipe, 20L/min, 600kPa with DIN 52218 noise source.

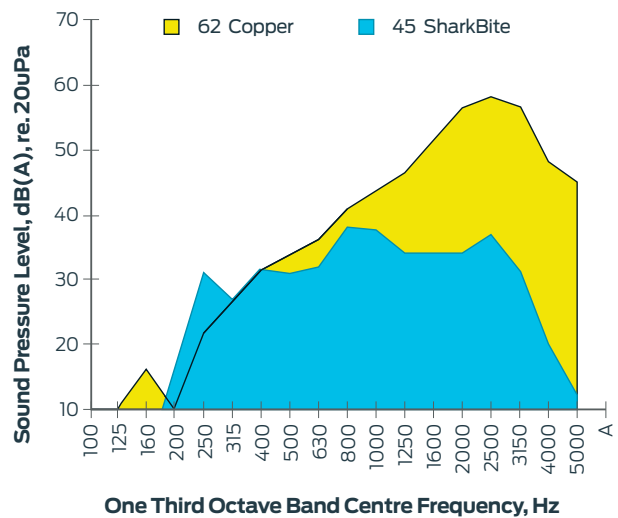

Measured noise level of water flow through nominal 15mm bore SharkBite and copper pipe, 20L/min, 700kPa with DIN 52218 noise source.

## UV Resistance

SharkBite pipe should not be installed in direct or reflected sunlight as the material may degrade with extended UV exposure. Where external installation is required, install the SharkBite pre-conduited product or provide other similar UV protection.

## SharkBite Burial

SharkBite fittings are suitable for burial in most applications; however care is required when using fittings in applications that require burial to ensure the correct installation practices are used and due care is given to any environmental factors that may have a detrimental effect on the life expectancy of the fittings and pipe.

The installation of SharkBite fittings that require burial or chasing into concrete or brickwork, must comply with all local plumbing code requirements. SharkBite fittings are not suitable for use in areas where the soil is or may become contaminated\* including the soil used for back filling. It is recommended that all SharkBite fittings have an impervious barrier between the fitting and the surrounding soil (*RWC Silicone Burial Wrap*).

The soil used for back filling must be free of rocks, debris or any sharp objects that may cause damage to the fitting or pipe through impact or abrasion.

\* *Examples of contamination include, but are not limited to: petrochemicals (reclaimed service station sites), high levels of nitrogen compounds (this could be caused by animal waste or fertilizer that may be found in some agricultural applications), low pH levels (below pH 6), high pH levels (above pH 8), run off from land fill, formaldehyde compounds, and solvents. It should be noted that such contaminants have been known to migrate through plastic piping systems and contaminate the Potable water supplied through these pipes.*

## RWC Silicone Burial Wrap

When using RWC Silicone Burial Wrap, make a SharkBite connection ensuring pipe is inserted correctly in the fitting (see Installation Instructions in this manual for details). While leaving the protective film in place, measure the amount of tape needed to completely wrap the fitting. To ensure a proper seal, overlap tape by 25mm past the end of the fitting on every end and 5mm – 10mm between/ across the fitting.

Completely cover the fitting by wrapping (overlapping each edge of the tape) the fitting, pulling the tape tight and removing the protective film. The tape will bond to itself within minutes and form an impervious barrier within a few hours.

## Uncontrolled Heat Sources

In the case of uncontrolled heat sources (eg. Slow combustion stoves, water heating coils, wet back boilers, solar, or similar) SharkBite PEX pipe should not be used. The primary flow and returns on these types of heaters should not be installed in SharkBite PEX pipe. Secondary flow and returns must be controlled so that the temperature / pressure requirements are not exceeded.

In the interest of safe temperature and to protect the user, tempering valves should be installed in accordance with AS/NZS3500.

When using solar systems, installers should consult with manufacturers to ensure that water leaving the storage facilities does not exceed the performance capabilities of the pipe. Primary flow and returns should not be installed in SharkBite PEX pipe and secondary flow and returns must be controlled.

## Water Quality and Chlorine

Potable water is sourced using a variety of methods. The Australian Drinking Water Guidelines provides a framework to govern potable water. To achieve this, chlorine and other agents are sometimes used as constituents of the water. Chlorine levels within the levels of the Australian Drinking Water Guidelines are in most cases suitable in standard discontinuous flow applications. For continuous flow applications such as circulating hot water lines a maximum chlorine level of 1.2ppm must be maintained.

Water pH levels must be greater than 7.5. Should the installer have concerns relating to water chemistry including chlorine levels for a particular site or application they should contact RWC for further information.

## Disinfection of Plumbing System

The SharkBite plumbing system is compliant and certified to AS/NZS 2537 and AS 2492 and as such all components of the system have been certified to AS/NZS 4020. RWC can confirm, based on the AS/NZS 4020 certification that the SharkBite system does not cause any multiplication of micro-organisms, microbial contamination. RWC recommend that an independently accredited provider is engaged to undertake any thermal disinfection or chemical flush of the system and that this work is carried out in line with the relevant Standards. Chemical flushes must be limited to a maximum of 5 occurrences over the system lifetime and records must be maintained showing when disinfection took place, what process was followed and who undertook the disinfection works.

Chemical flushing is to be done in line with the Australian Drinking Water Guidelines. The guidelines prohibit flushing potable plumbing systems with a solution greater than 5ppm of chlorine and within the normal operating temperatures and pressures (as specified in the SharkBite Technical Literature). If chemical flushing with a high concentration solution of chlorine is conducted incorrectly it will have a detrimental effect on any piping system. Dosing must be done in such a way as not to exceed the 5ppm chlorine level in any part of the plumbing system. Thermal disinfection processes must be conducted within the normal operating conditions of the SharkBite plumbing system.

## Installation Considerations

- Keep SharkBite PEX pipe at a minimum of 500mm from sources of high heat such as heating appliances (e.g. flues)
- Keep SharkBite PEX pipe 1500mm from slow combustion type stoves (wet back type).
- Leave 300mm minimum space between SharkBite PEX pipe and recessed electric light fittings.
- SharkBite PEX pipe should not be positioned within 150mm of gas or central heating vents or flues.
- Where fire collars or the like are required, installers should contact the manufacturer of those products to ensure they have certification for use with PEX pipes.

## Minimum Cold Bending Radii

DIAMETER	RADII
16mm	160mm
20mm	200mm
25mm	250mm

*Ten times the outside diameter of the pipe used*

Bending of the SharkBite PEX pipe for change of direction is preferable to elbows, however fittings will be required where sharp bends are necessary. Tighter bends can be achieved by using a bend support.

Note: Do not use pipes that have kinks, cuts, deep scratches, squashed ends, imperfections or have been in contact with grease or tar substances. Any of the above should be cut out and replaced, as these conditions may affect the integrity of the SharkBite system.

## Clipping

AS/NZS 3500 recommend the following spacings:

Diameter	Horizontal	Vertical
16mm	600mm	1200mm
20mm	700mm	1400mm
25mm	750mm	1500mm

The above is a guide only. Good plumbing practice requires that clipping be installed so that stress is not imposed on the joint. When bending close to a joint, clips should be placed near the fitting in a manner not to stress the joint.

## Timber & Steel Frames

Drill holes through studs, plates etc. large enough so that the SharkBite pipe can move freely to allow for expansion and contraction and pressure surges.

Holes drilled or formed in metal studs or plates must be accurately sized to enable suitable grommets. Insulation or a short sleeve of oversize pipe should also be firmly secured in the framework to be inserted around the pipe. This helps to ensure that there is no direct contact between the pipe and framework and allows for movement of the pipe through the grommet, lagging or sleeve. To avoid noises where pipes pass through studs, plates etc. That have large holes, consideration should be given to the use of a non-aggressive compound, grommet or sleeve in the annular space in the stud or plate.

AS/NZS 3500 allows neutral cure silicone to be used around PE-X pipes to fill the annular space drilled through a stud or plate.

SharkBite fittings must be located away from stud penetrations or other abutments to ensure the fittings demount function is not engaged due to the effects of thermal expansion/contraction.

## Pipes In Chases, Ducts or Conduits

- SharkBite PEX pipes in chases must be continuously wrapped with an impermeable flexible material
- Ducts shall be fitted with removable covers
- Conduits embedded in walls or floors should conform to the requirements of the NCC or New Zealand Building Codes as applicable

Although water service pipes are not permitted to be embedded or cast directly into a concrete structure it is permissible for a water service pipe to be within a conduit and then embedded within a wall or floor of masonry or concrete construction.

Refer to AS/NZS 3500 – 5.4.3



## Under Concrete Slabs

Water pipes located beneath slabs on ground shall be laid on a compacted bed of sand or fine-grained soil with a minimum distance of 75mm between the top of the underside of the slab. Pipe work that penetrates the slab shall be at right angles to the slab surface and lagged the full length of the slab penetration with an impermeable flexible material not less than 6mm in thickness. Alternatively, an impermeable plastic sleeves or conduit providing equivalent protection.

Any joints located beneath a concrete slab should be kept to a minimum and fitting protection applied.

Refer to *SharkBite Burial* (page 8)

## Thermal Properties

PEX pipe will not melt. This is due to the irreversible cross-linking process which has changed the chemical structure of the base polyethylene.

PROPERTY	VALUE
Ignition Temperature °C	380
Specific Heat (J/kg/K)	2300
Density (g/cm <sup>3</sup> )	0.94
Thermal Expansion Coefficient (x10 <sup>-6</sup> /K)	14.22

## Thermal Expansion

The table below represents expansion and contraction of PEX pipe in millimetres, resulting from a given change in temperature. The graph and table are calculated using the following equation:

$$\text{Change in pipe length} = 0.1422 \times \text{Pipe length} \times \text{Change in temperature}$$

		CHANGE IN TEMPERATURE (°C)															
		10	12	14	16	18	20	22	24	26	28	30	32	34	36	38	40
LENGTH OF PIPE IN METRES	1	1.4	1.7	2.0	2.3	2.6	2.8	3.1	3.4	3.7	4.0	4.3	4.6	4.8	5.1	5.4	5.7
	2	2.8	3.4	4.0	4.6	5.1	5.7	6.3	6.8	7.4	8.0	8.5	9.1	9.7	10.2	10.8	11.4
	4	5.7	6.8	8.0	9.1	10.2	11.4	12.5	13.7	14.8	15.9	17.1	18.2	19.3	20.5	21.6	22.8
	6	8.5	10.2	11.9	13.7	15.4	17.1	18.8	20.5	22.2	23.9	25.6	27.3	29.0	30.7	32.4	34.1
	8	11.4	13.7	15.9	18.2	20.5	22.8	25.0	27.3	29.6	31.9	34.1	36.4	38.7	41.0	43.2	45.5
	10	14.2	17.1	19.9	22.8	25.6	28.4	31.3	34.1	37.0	39.8	42.7	45.5	48.3	51.2	54.0	56.9
	12	17.1	20.5	23.9	27.3	30.7	34.1	37.5	41.0	44.4	47.8	51.2	54.6	58.0	61.4	64.8	68.3
	14	19.9	23.9	27.9	31.9	35.8	39.8	43.8	47.8	51.8	55.7	59.7	63.7	67.7	71.7	75.7	79.6
	16	22.8	27.3	31.9	36.4	41.0	45.5	50.1	54.6	59.2	63.7	68.3	72.8	77.4	81.9	86.5	91.0
	18	25.6	30.7	35.8	41.0	46.1	51.2	56.3	61.4	66.5	71.7	76.8	81.9	87.0	92.1	97.3	102.4
	20	28.4	34.1	39.8	45.5	51.2	56.9	62.6	68.3	73.9	79.6	85.3	91.0	96.7	102.4	108.1	113.8
	22	31.3	37.5	43.8	50.1	56.3	62.6	68.8	75.1	81.3	87.6	93.9	100.1	106.4	112.6	118.9	125.1
	24	34.1	41.0	47.8	54.6	61.4	68.3	75.1	81.9	88.7	95.6	102.4	109.2	116.0	122.9	129.7	136.5
	26	37.0	44.4	51.8	59.2	66.5	73.9	81.3	88.7	96.1	103.5	110.9	118.3	125.7	133.1	140.5	147.9
	28	39.8	47.8	55.7	63.7	71.7	79.6	87.6	95.6	103.5	111.5	119.4	127.4	135.4	143.3	151.3	159.3
	30	42.7	51.2	59.7	68.3	76.8	85.3	93.9	102.4	110.9	119.4	128.0	136.5	145.0	153.6	162.1	170.6
32	45.5	54.6	63.7	72.8	81.9	91.0	100.1	109.2	118.3	127.4	136.5	145.6	154.7	163.8	172.9	182.0	
34	48.3	58.0	67.7	77.4	87.0	96.7	106.4	116.0	125.7	135.4	145.0	154.7	164.4	174.1	183.7	193.4	
36	51.2	61.4	71.7	81.9	92.1	102.4	112.6	122.9	133.1	143.3	153.6	163.8	174.1	184.3	194.5	204.8	
38	54.0	64.8	75.7	86.5	97.3	108.1	118.9	129.7	140.5	151.3	162.1	172.9	183.7	194.5	205.3	216.1	
40	56.9	68.3	79.6	91.0	102.4	113.8	125.1	136.5	147.9	159.3	170.6	182.0	193.4	204.8	216.1	227.5	

## Thermal Insulation

R-Values of Common Plumbing Piping and Insulation. In certain areas, AS/NZS 3500 requires a minimum insulation of R=0.3. No current piping material will meet this requirement without suitable thermal insulation.

*"R-value = Thickness / Conductivity. See AS/NZS 3500 Section 8.6"*

	CONDUCTIVITY (K)W/M/K	OD mm	ID mm	WALL THICKNESS mm	R-VALUE K.M <sup>2</sup> /W
Air	0.02			6	0.300
Copper DN15	401	12.7	10.88	.91	0.0000023
Lagged Copper (Approx.)	Cu + Air + Plastic			~2	0.034
SharkBite PEX 16mm	0.35	16	11.6	2.2	0.006
SharkBite PEX 20mm	0.35	20	15.1	2.45	0.007
SharkBite PEX 25mm	0.35	25	18.6	3.2	0.009
E-Therm™	0.034			8	0.235
Requirement Of AS/NZS 3500 5.19 DN15	0.03			9	0.300
Requirement Of AS/NZS 3500 2003 Amendment 1 2005 (Table 8.1 & 8.2)	0.0433			13	0.300

## Operating Parameters – Pressure and Temperature

### SharkBite PEX SDR9 Pipe is manufactured to AS 2492

Designed to operate with a working pressure of 2000kPa at 20°C and can be operated at 70°C with a maximum working pressure of 1000kpa (see special conditions relating to Recirculating Systems on page 8).

Temperature above 70°C for any period will affect the life of the pipe.

Designated SharkBite connection can only be used on SharkBite PEX SDR9 Pipe.

The table below represents the working pressures of cross-linked polyethylene PN20 pipe at various pipe material temperatures (PMT) as per AS 2492.

TEMPERATURE	20°C	60°C	70°C
kPa	2000	1190	1000

## Fitting Pressure Loss

To calculate the pressure loss through a particular fitting, the type and diameter of the fitting and the flow rate must be established. The pressure loss may then be read from the vertical axis. To calculate the pressure loss through a number of fittings in a circuit, the number and type of fittings, along with the direction of flow must be known. The pressure loss through each fitting can then be added together to calculate a total pressure loss.

### Elbows – Head Loss In kPa Per Fitting

FITTING SIZE	FLOW RATES PER SECOND								
16mm	1.0	3.5	11.9	21.2	33.1	47.6	64.8	84.7	107.1
20mm	0.3	1.0	4.3	7.6	11.9	17.2	23.4	30.5	38.6
25mm	0.1	0.4	1.8	3.2	5.1	7.3	9.9	13.0	16.4

### Straight Connectors – Head Loss In kPa Per Fitting

Due to the design of the SharkBite copper fitting, there is no significant pressure loss through a straight connection. Pressure loss is to be calculated as a straight length of tube.

FITTING SIZE	FLOW RATES PER SECOND								
16mm	0.4	1.6	3.6	6.3	9.9	14.3	19.4	25.4	32.1
20mm	0.1	0.6	1.3	2.3	3.6	5.1	7.0	9.2	11.6
25mm	0.1	0.2	0.5	1.0	1.5	2.2	3.0	3.9	4.9

## Pressure or Head Loss Through PEX Pipe

This graph shows pressure loss through SharkBite PEX Pipe at various flow rates in 16mm and 20mm.

In order to calculate the pressure loss through the pipe, the given flow rate for a particular portion of tube must be established (this may be done using the table provided in AS/NZS 3500), along with the required pipe length and diameter. The pressure loss can then be read off the vertical axis.

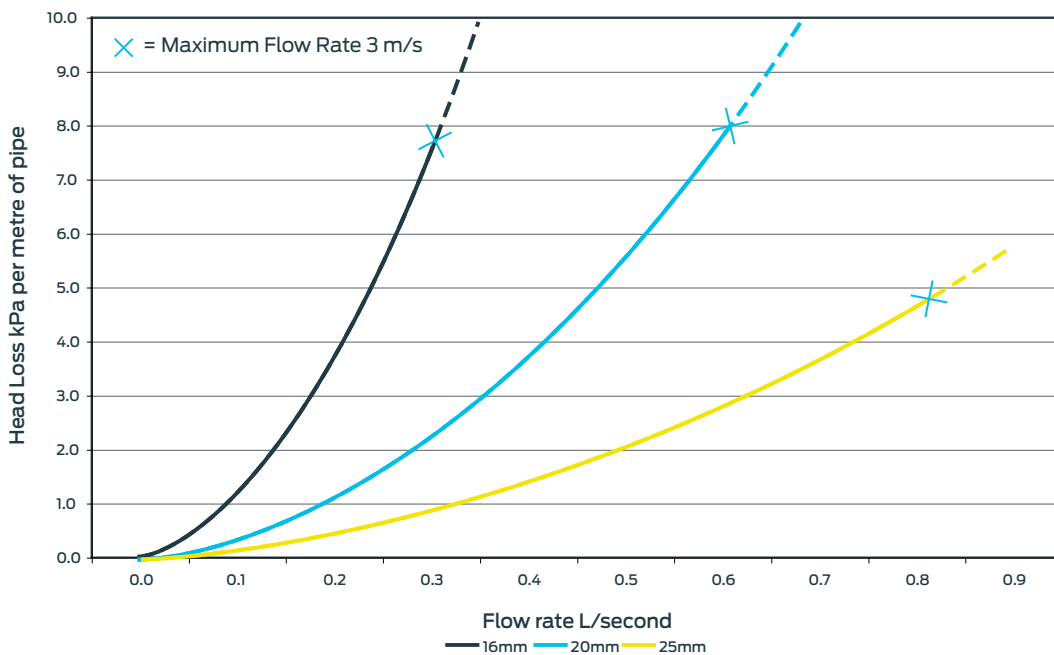

Information provided here is theoretical and based on new clean pipe. No allowance has been made for age or any abnormal conditions of the interior surface of the pipe.

## Maximum Flow Rates

	SHARKBITE PEX PIPE SDR9			COPPER TUBE		
	16mm	20mm	25mm	DN15	DN20	DN25
MIN ID (MM)	11.5	15.0#	18.7	10.7	17.0	23
MAX FLOW (L/MIN)*	18.7	31.8	49.4	16.2	40.9	74.8
MAX FLOW (L/SEC)*	0.31	0.53	0.82	0.27	0.68	1.25

\* Based on AS/NZS 3500 maximum allowable velocity in pipe of 3m/s.

Based on its minimum ID of 15mm, 20mm SharkBite may be used where AS/NZS 3500 requires a nominal pipe size of DN20 (eg. Section 3.5.1). This is a feature of SharkBite pipe only, and not generally applicable to PEX pipe.

## Pipe Flow Characteristics

FLOW RATE (l/min) VS HEAD LOSS (kPa)

PIPE SIZE	4l/min	8l/min	12l/min	16l/min	20l/min	24l/min	28l/min	32l/min	36l/min	40l/min	44l/min	48l/min	52l/min
16mm	0.59	1.75	3.71	6.33	9.57	-	-	-	-	-	-	-	-
20mm	0.14	0.52	1.09	1.86	2.82	3.95	5.25	6.72	-	-	-	-	-
25mm	0.05	0.17	0.36	0.61	0.92	1.29	1.71	2.19	2.73	3.32	3.96	4.65	5.49

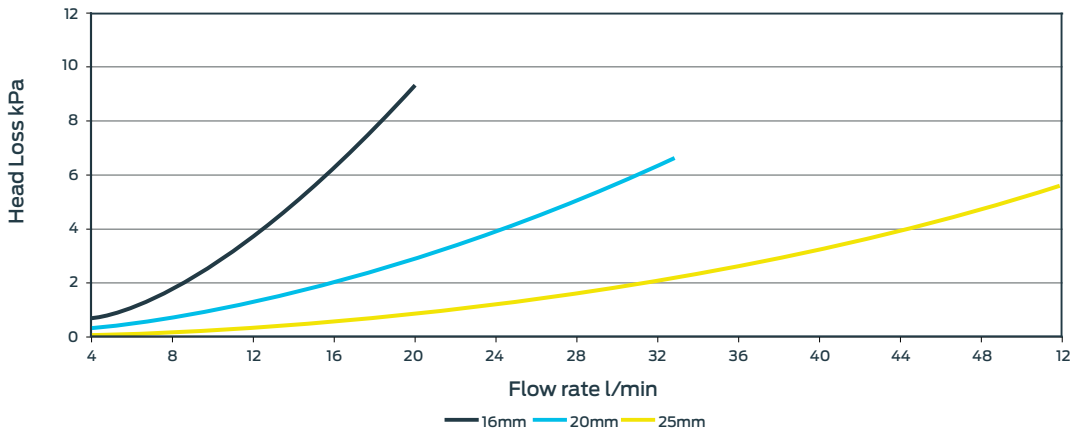

16mm PEX		20mm PEX		25mm PEX	
Velocity	Flow Rate	Velocity	Flow Rate	Velocity	Flow Rate
1.0m/s	6.6l/min	1.0m/s	11.0l/min	1.0m/s	17.5l/min
2.0m/s	16.4l/min	2.0m/s	22.1l/min	2.0m/s	35.0l/min
3.0m/s	20.0l/min	3.0m/s	33.1l/min	3.0m/s	52.0l/min



## SharkBite Push-To-Connect Plumbing System

The SharkBite fitting works via a two-stage process that ensures a quick, easy connection. In one easy push, the SharkBite fittings advanced design seals and locks the pipe securely.

**Stage ONE** As the pipe is inserted into the fitting, it passes through the release collar and then through the 316-stainless steel grab ring. The grab ring opens out and grabs the pipe, preventing it from being withdrawn.

**Stage TWO** The pipe then passes through the O-Ring protector. This aligns the pipe before it passes through the specially formulated EDPM O-Ring which compresses between the pipe OD and the wall of the fitting, creating a seal. When the pipe reaches the tube support stop, a secure joint has been made.

If required, the pipe and fitting can be easily disconnected using SharkBite Disassembly Clips. Simply apply pressure to the release collar. This releases the grab ring teeth, allowing the pipe to be withdrawn from the fitting.

Refer to this manual for detailed connection and disconnection instructions.

SharkBite PEX fittings are designed for use only on SharkBite PEX pipe.

SharkBite copper fittings are designed for use only with copper pipe that conforms with and is approved to AS 1432.

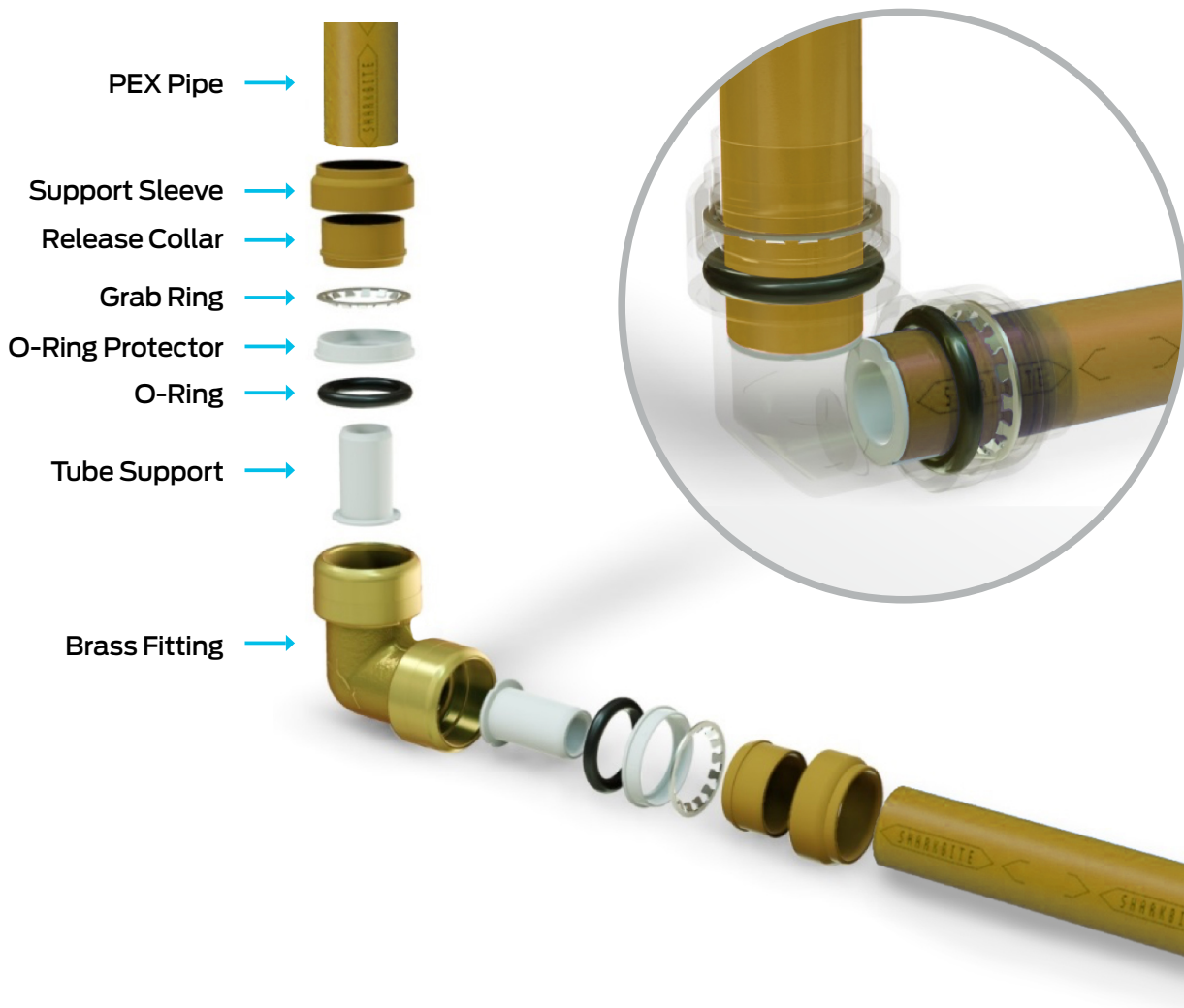

## Connection of PEX Fittings

- Used to connect only SharkBite PEX pipe
- PEX fittings have mustard coloured ends
- Fittings are rotatable after connection
- Fittings can be installed on wet pipe even with water flowing
- Fittings can be disconnected and reconnected as required



## Installation

1. All pipe should be free of damage or debris. Cut PEX pipe with quality PEX cutters. Cutters with blunt or damaged blades may damage the pipe, causing failure.
2. SharkBite PEX pipe is supplied with pre-gauged "Safe Seal Indicator Marks" (SSIM) for faster installation. Cut between the SSIM.
3. Simply push to the next SSIM.

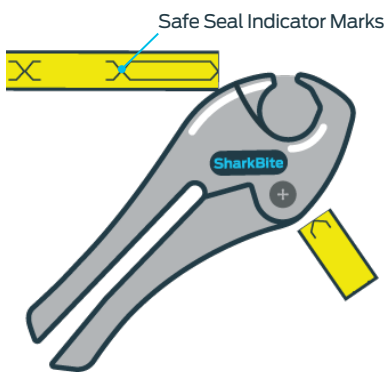

### Cut

Using SharkBite PEX Pipe Cutters, cut the pipe squarely between two of the SharkBite safe seal indicator marks as shown in the picture. Ensure pipe is round, clean and free of debris.

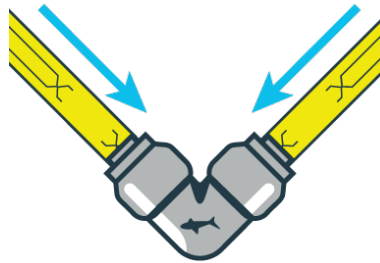

### Push

Insert the pipe through the release collar to rest against the grab ring. Push the pipe firmly with a twisting action and push to the SharkBite safe seal indicator mark.

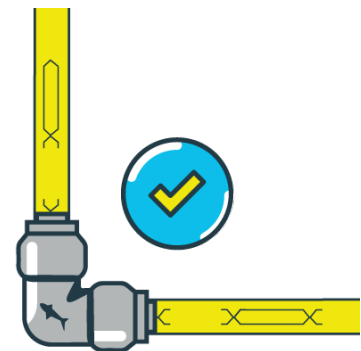

### Done

Ensure the SharkBite Safe Seal Indicator Mark aligns with the release collar as shown.

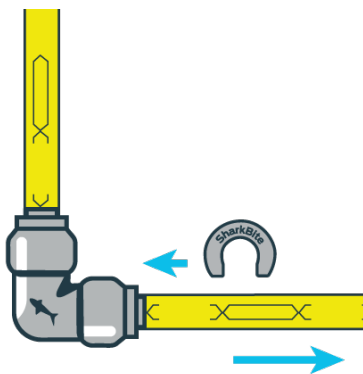

### Disassembly

Using the Disassembly Clip, fittings can be easily changed, removed and the fittings reused.

**Note:** Safety precautions need to be observed when cutting into pipework or disconnecting water meters, fittings and devices on pipework. There have been fatalities and injuries that have been attributed to water services carrying an electrical current.

Any existing metallic service pipework is to be replaced in part or in its entirety by plastics pipe or other non-metallic fittings or couplings, the work should not commence until the earthing requirements have been checked by an electrical contractor and modified, if necessary.

## Connection of Copper Fittings

- Used to connect copper systems
- Copper fittings have black coloured ends
- A range of fittings and adapters are available

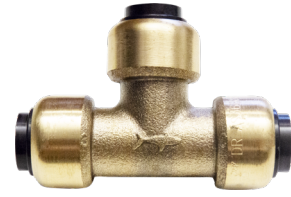

## Installation

1. All pipe should be free of damage or debris. Cut copper pipe with a tube cutter. Do not use a hacksaw, as this will cause damage to the pipe ends.
2. Deburr the end of the pipe using the SharkBite F702 Deburring tool. Be sure to remove any sharp edges that may damage the O-Ring, as this will cause failure.
3. Mark the pipe with a marker, using the SharkBite F702 Gauge to determine the correct insertion depth.
4. Push the pipe into the fitting to the mark made in step 3. The mark should rest against the collar of the fitting, indicating correct insertion depth.

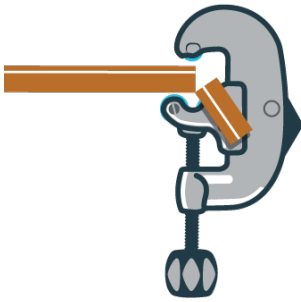

### Cut

Using a pipe cutter, cut the copper tube to length, making sure the pipe is cut squarely. Ensure pipe is round, clean and free of debris.

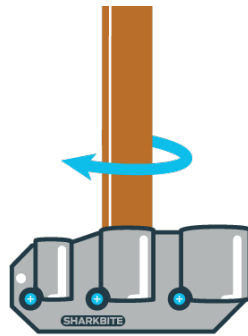

### Deburr

Remove burrs from the pipe using the SharkBite Deburrer and Depth Gauge.

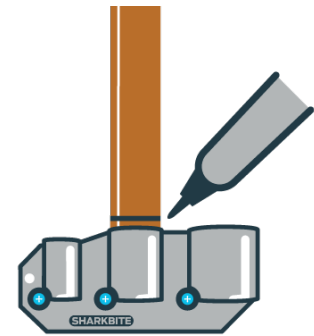

### Mark

Mark the pipe with a marker using the Depth Gauge.

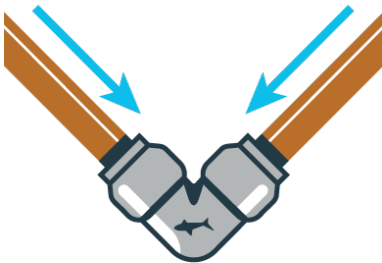

### Push

Insert the pipe by pushing firmly until a positive click is heard.

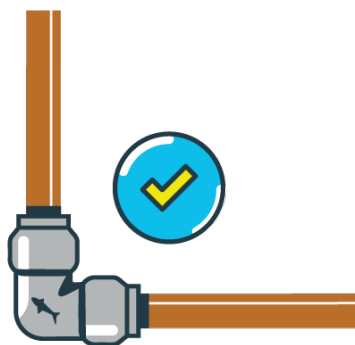

### Done

Ensure the mark made with Depth Gauge aligns with the release collar.

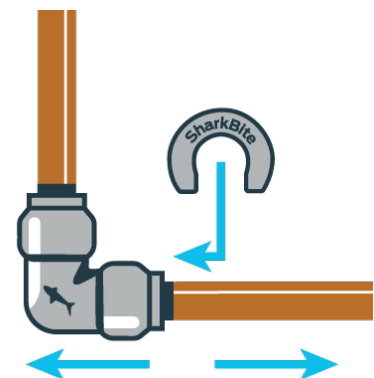

### Disassembly

Using the Disassembly Clip, fittings can be easily changed, removed and the fittings reused.

*Installation per AS/NZS 3500*

## Disconnecting Fittings

SharkBite fittings are designed to accommodate simple changes during installation.

When reusing fittings, ensure the fitting and pipe connection have not been compromised before reinstalling. Visit the Installation Trouble Shooting section for more details.

Additionally, copper tube connected to a SharkBite fitting does not guarantee electrical continuity.

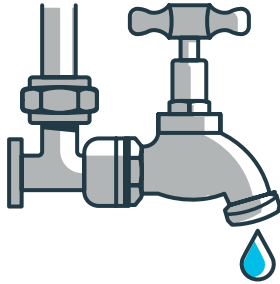

### Relieve Pressure

Ensure all system pressure has been relieved and drained where possible, although draining is not mandatory. SharkBite can be installed wet or dry.

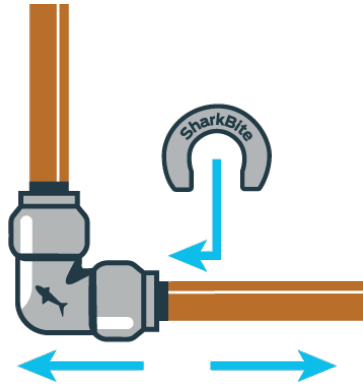

### Disconnect

Place the Disconnection Clip over the pipe with the flat face towards the fitting release collar. Apply pressure to the clip against the collar, and with your free hand, remove the pipe.

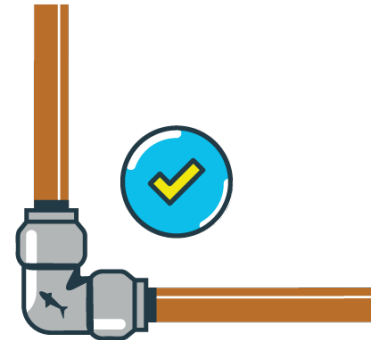

### Re-use

Refer to the SharkBite Installation procedure when remaking a joint.

Note: Always recut pipe as damage may have been done during disconnection.

## Use approved SharkBite Disconnection tools

### DISCONNECTION CLIPS

\*Suitable for use on 16mm & 20mm pipes only



## Installation Requirements

Installation is subject to the requirements of the applicable regulatory authority, the National Construction Code Volume Three – Plumbing Code of Australia, associated reference standards as applicable at the time and AS/NZS 3500. This product is compliant to the Lead Free requirements of the National Construction Code Volume Three. For further Scope of Use, please visit [www.rmc.com.au](http://www.rmc.com.au)

The SharkBite Push-to-Connect Plumbing System is simple and effective when executed in accordance with the jointing procedures in this manual. However, if sufficient care is not taken, this can result in an ineffective joint.

SharkBite fittings are not suitable for use on stainless steel pipe.

## Installation Best Practice

- ALL SharkBite O-Rings are pre-lubricated during manufacture, do not apply additional lubrication.
- Cut the pipe square – use SharkBite cutting tools with sharp, undamaged cutting blades to ensure a clean, square cut. Do not use a hacksaw when cutting copper pipe and use the SharkBite Deburring & Gauge Tool to ensure the ends are free from burrs.
- Keep it clean – ensure your SharkBite PEX and fittings are free from building-site contamination such as dirt, sand, sawdust, concrete dust etc.
- To ensure fittings stay clean and the O-Ring is protected from damage, fittings must be kept in their original packaging until immediately prior to installation .
- Push the pipe all the way in – use the Safe Seal Indicator Marks on PEX or the SharkBite Deburring & Gauge Tool as a depth indicator on copper to ensure the pipe has achieved full insertion .
- If the pipe is difficult to insert or will not engage into the fitting do not force the pipe. Remove and check for obstructions inside the fitting and check for damage to the end of the pipe.
- If SharkBite pipe is to be refitted to a SharkBite fitting, it is important to trim the pipe before remaking the joint.
- SharkBite fittings are not to be installed back to back. A minimum distance of 1 Safe Seal Indicator Mark for PEX and 25mm for copper, is required.
- If you are soldering/sweating copper pipe solder/sweat all connections first then make the SharkBite connections – Do NOT solder next to SharkBite connection.
- SharkBite copper fittings may be used on annealed copper tube, however, achieving a watertight connection may be difficult. Using an alternate connection method may be more suitable.
- Always pressure test with water on completion and before covering the pipe.
- Always look for the shark – beware of imitators, you can tell genuine SharkBite fittings from the embossed shark icon on the body of the fitting.





### Ineffective Joints Most Often Occur When:

- There is debris or foreign matter inside the fitting
- The PEX or copper pipe has not been cut square
- The PEX or copper pipe has rough edges, cuts, abrasions or other damage
- The PEX pipe has been cut with blunt or damaged tools
- The copper pipe has been cut with a hack-saw
- Correct pipe insertion depth has not been achieved



Cutting tool damaged

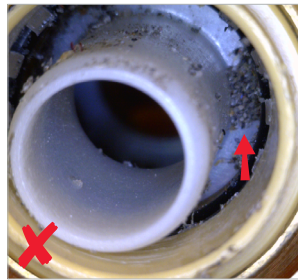

Dirt/debris inside fitting



Pipe has not been cut square

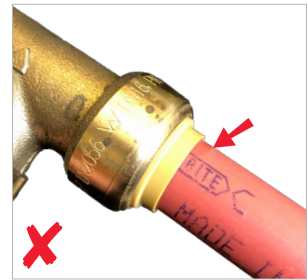

Short engagement – pipe not inserted correctly

### If an ineffective joint is detected

- Disconnect the defective joint and recut the pipe to ensure it is square and free from damage
- Check the fitting is clean and there has been no damage to the grab ring or O-Ring
- Re-install the fitting as per instructions in this manual
- If the joint fails a pressure test, discard fitting and repeat these steps with a new fitting





# SharkBite Range





F008X

### F1 Straight Coupling

Order Code	Old Code	Description	Available in
F008X	F008	16mm OD Both Ends	10pk
F016X	F016	20mm OD Both Ends	10pk
F020X	F020	25mm Both Ends (Suits PEX or Copper)	1pk



F058X

### F1 Reducing Coupling

Order Code	Old Code	Description	Available in
F058X	F058	20mm OD x 16mm OD	10pk
F060X	F060	25mm x 20mm OD PEX (Only 25mm end suits PEX or Copper)	1pk



F072X

### F2 Straight Connector

Order Code	Old Code	Description	Available in
F072X	F072	16mm OD x 15mm FI	10pk
F068X	F068	16mm OD x 20mm FI	5pk
F088X	F088	20mm OD x 20mm FI	5pk
F094X	F094	25mm x 25mm FI (Suits PEX or Copper)	1pk



F120X

### F3 Straight Connector

Order Code	Old Code	Description	Available in
F120X	F120	16mm OD x 15mm MI	10pk
F116X	F116	16mm OD x 20mm MI	5pk
F138X	F138	20mm OD x 15mm MI	5pk
F134X	F134	20mm OD x 20mm MI	5pk
F142X	F142	25mm x 20mm MI (Suits PEX or Copper)	1pk
F140X	F140	25mm x 25mm MI (Suits PEX or Copper)	1pk



### F12 Elbow

Order Code	Old Code	Description	Available in
F248X	F248	16mm OD	10pk
F256X	F256	20mm OD	10pk
F260X	F260	25mm OD (Suits PEX or Copper)	1pk



### F13 Elbow

Order Code	Old Code	Description	Available in
F280X	F280	16mm OD x R $\frac{1}{2}$ "-15	5pk
F286X	F286	20mm OD x R $\frac{3}{4}$ "-20	100pk



### F14 Elbow

Order Code	Old Code	Description	Available in
F308X	F308	16mm OD x RP $\frac{1}{2}$ "-15	5pk
F314X	F314	20mm OD x G $\frac{3}{4}$ "	100pk



### F15BP Female Lugged Elbow

Order Code	Old Code	Description	Available in
F334X	F334	16mm OD x 15mm FI	5pk
F340X	F340	20mm OD x 20mm FI	5pk

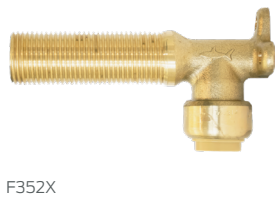

### F19BP Male Lugged Elbow

Order Code	Old Code	Description	Available in
F350X	F350	16mm OD x 15mm MI x 75mm	10pk
F351X	F351	16mm OD x 15mm MI x 185mm	5pk
F352X	F352	16mm OD x 15mm MI x 100mm	5pk
F354X	F354	20mm OD x 20mm MI x 200mm	5pk
F356X	F356	20mm OD x 15mm MI x 100mm	5pk
F358X	F358	20mm OD x 15mm MI x 200mm	5pk

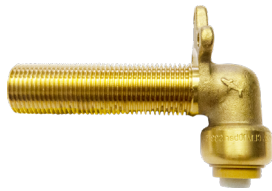

F336X

### Top-Plated Male Elbow

Order Code	Old Code	Description	Available in
F336X	F336	16mm OD x 15mm MI x 100mm	5pk
F336X-230	F336-230	16mm OD x 15mm MI x 230mm	5pk

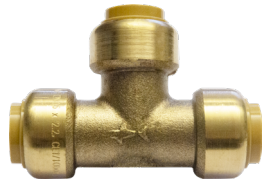

F362X

### F24 Tee

Order Code	Old Code	Description	Available in
F362X	F362	16mm OD x 16mm OD x 16mm OD	10pk
F370X	F370	20mm OD x 20mm OD x 20mm OD	10pk
F374X	F374	25mm x 25mm x 25mm (Suits PEX or Copper)	1pk

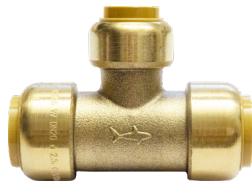

F412X

### F25 Unequal Tee

Order Code	Old Code	Description	Available in
F412X	F412	20mm OD x 20mm OD x 16mm OD	10pk
F416X	F416	25mm x 25mm x 20mm OD	1pk

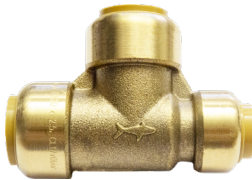

F444X

### F26 Unequal Tee

Order Code	Old Code	Description	Available in
F444X	F444	20mm OD x 16mm OD x 20mm OD	10pk

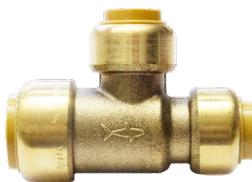

F454X

### F27 Unequal Tee

Order Code	Old Code	Description	Available in
F454X	F454	20mm OD x 16mm OD x 16mm OD	10pk





F514X

### F61 Stop End

Order Code	Old Code	Description	Available in
F514X	F514	16mm OD	10pk
F518X	F518	20mm OD	5pk
F520X	F520	25mm (Suits PEX or Copper)	1pk



F526X

### F62 Straight Tap Connector

Order Code	Old Code	Description	Available in
F526X	F526	16mm OD x 15mm Nut	10pk
F530X	F530	20mm OD x 20mm Nut	5pk



F532X

### F63 Bent Tap Connector

Order Code	Old Code	Description	Available in
F532X	F532	16mm OD x 15mm Nut	10pk



F600X

### Copper / PEX Braising Tail

Order Code	Old Code	Description	Available in
F600X	F600	DN15 CU x 16mm OD Tail	10pk
F606X	F606	DN20 CU x 20mm OD Tail	10pk



F610X

### PEX Flare Compression Adaptor

Order Code	Old Code	Description	Available in
F610X	F610	16mm OD x 15mm Flare	10pk
F612X	F612	20mm OD x 20mm Flare	5pk



F630X

### Recessed Assembly – Lugged

Order Code	Old Code	Description	Available in
F630X	F630	300mm Right Angled Breech	1pk
F632X	F632	200mm Right Angled Breech	1pk

*All breech outlets must be supported to restrict movement.*



F650X

### Shower Assembly – Lugged (Without Riser)

Order Code	Old Code	Description	Available in
F650X	F650	200mm Right Angled	1pk
F652X	F652	150mm Right Angled	1pk



F690X-3T

### Manifolds

Order Code	Old Code	Description
F690X-3T	F690-3T	20mm PEX x 3 Way 16mm Take Offs x 20mm PEX

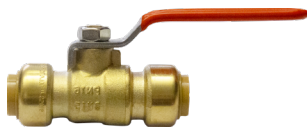

F670X

**DR Ball Valve PEX Connections**

Order Code	Old Code	Description	Available in
F670X	BVF670	16mm OD x 16mm OD	1pk
F672X	BVF672	20mm OD x 20mm OD	1pk
F674X	BVF674	25mm x 25mm (Suits PEX or Copper)	1pk

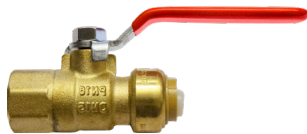

F680X

**DR Ball Valve PEX Connection / Female**

Order Code	Old Code	Description	Available in
F680X	BVF680	16mm OD x 15 FI	1pk
F682X	BVF682	20mm OD x 20 FI	1pk
F684X	BVF684	25mm x 25 FI (Suits PEX or Copper)	1pk

## No.1 Straight Coupling



RA008X

Order Code	Old Code	Description	Available in
RA008X	RA008	DN15 Coupling	10pk
RA016X	RA016	DN20 Coupling	10pk
F020X	F020	25mm Coupling (Suits PEX or Copper)	1pk

## No.1R Reducing Coupling



RA058X

Order Code	Old Code	Description	Available in
RA058X	RA058	DN20 x DN15 Coupling-Reducing (Suits PEX or Copper)	10pk

## Slip Coupling



RA3008X

Order Code	Old Code	Description	Available in
RA3008X	RA3008	Slip Coupling DN15	5pk
RA3016X	RA3016	Slip Coupling DN20	5pk

## No.2 Straight Connector



RA072X

Order Code	Old Code	Description	Available in
RA072X	RA072	DN15 x 15mm FI Connector Straight	10pk
RA088X	RA088	DN20 x 20mm FI Connector Straight	5pk
F094X	F094	25mm x 25mm FI Connector Straight (Suits PEX or Copper)	1pk

## No.3 Straight Connector

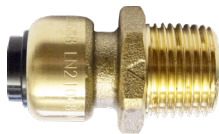

RA120X

Order Code	Old Code	Description	Available in
RA120X	RA120	DN15 x 15mm MI Connector Straight	10pk
RA134X	RA134	DN20 x 20mm MI Connector Straight	10pk
F140X	F140	DN25 x 25mm MI Connector Straight (Suits PEX or Copper)	1pk
F142X	F142	25mm x 20mm MI Connector Straight 25mm (Suits PEX or Copper)	1pk



RA248X

## No.12 Elbow

Order Code	Old Code	Description	Available in
RA248X	RA248	DN15 Elbow	10pk
RA256X	RA256	DN20 Elbow	10pk
F260X	F260	DN25 Elbow (Suits PEX or Copper)	1pk



RA334X

## No. 15BP Female Lugged Elbow

Order Code	Old Code	Description	Available in
RA334X	RA334	DN15 x 15mm FI Elbow Lugged	5pk
RA340X	RA340	DN20 x 20mm FI Elbow Lugged	5pk



RA350X

## No. 19BP Male Lugged Elbow

Order Code	Old Code	Description	Available in
RA350X	RA350	DN15 x 15mm MIX75 Elbow Lugged	10pk
RA352X	RA352	DN15 x 15mm MIX100 Elbow Lugged	5pk



RA380X

## Hot Water Elbow

Order Code	Old Code	Description	Available in
RA380X	RA380	DN15 x 20mm MI	10pk

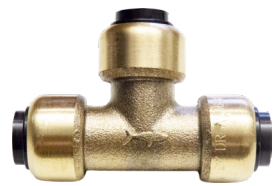

RA362X

## No. 24 Tees

Order Code	Old Code	Description	Available in
RA362X	RA362	DN15mm Tee	10pk
RA370X	RA370	DN20mm Tee	10pk
F374X	F374	25mm Tee (Suits PEX or Copper)	1pk

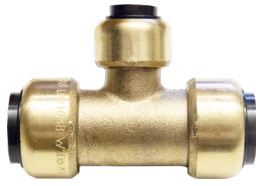

RA412X

## No. 25 Unequal Tee

Order Code	Old Code	Description	Available in
RA412X	RA412	DN20mm x DN20mm x DN15mm Tee Reducing	10pk



RA514X

## No. 61 Stop Ends

Order Code	Old Code	Description	Available in
RA514X	RA514	DN15mm Cap	10pk
RA518X	RA518	DN20mm Cap	5pk
F520X	F520	25mm Cap (Suits PEX or Copper)	1pk

## DR Ball Valves Copper Connections



BVRA670X

Order Code	Old Code	Description	Available in
RA670X	BVRA670	Ball Valve DN15mm x DN15mm	1pk
RA672X	BVRA672	Ball Valve DN20mm x DN20mm	1pk
F674X	BVF674	Ball Valve 25mm x 25mm (25mm Suits PEX or Copper)	1pk

## DR Ball Valves Copper Connection / Female



RA680X

Order Code	Old Code	Description	Available in
RA682X	BVRA682	Ball Valve DN20 x 3/4" FI BSP	1pk
F684X	BVF684	Ball Valve 25mm x 1" FI BSP (Suits PEX or Copper)	1pk

## DR Ball Valves Copper Connections / Male

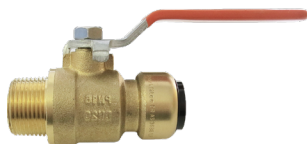

RA683X

Order Code	Old Code	Description	Available in
RA683X	BVRA682M	Ball Valve DN20mm x DN20mm	1pk





Potable Water

**PEX Pipe – Potable Water (Mustard)**

Order Code	Description	Available in
XF860	16mm x 5m Straight Length	10pk
XF864	16mm x 50m Coil	1pk
XF870	20mm x 5m Straight Length	10pk
XF874	20mm x 50m Coil	1pk
XF880	25mm x 5m Straight Length	5pk
XF882	25mm x 25m Coil	1pk



Hot Water

**PEX Pipe – Hot Water (Red)**

Order Code	Description	Available in
XF860R	16mm x 5m Straight Length	10pk
XF864R	16mm x 50m Coil	1pk
XF870R	20mm x 5m Straight Length	10pk
XF874R	20mm x 50m Coil	1pk
XF880R	25mm x 5m Straight Length	5pk
XF882R	25mm x 25m Coil	1pk

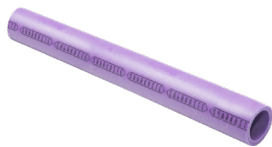

Recycled Water

**PEX Pipe – Recycled Water (Lilac)**

Order Code	Description	Available in
XF862L	16mm x 25m Coil	1pk
XF870L	20mm x 5m Straight Length	10pk
XF872L	20mm x 25m Coil	1pk
XF882L	25mm x 25m Coil	1pk

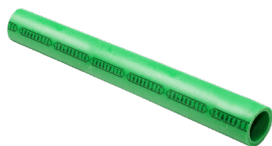

Rain Water

**PEX Pipe – Rainwater (Green)**

Order Code	Description	Available in
XF860G	16mm x 5m Straight Length	10pk
XF862G	16mm x 25m Coil	1pk
XF870G	20mm x 5m Straight Length	10pk
XF872G	20mm x 25m Coil	1pk
XF880G	25mm x 5m Straight Length	5pk
XF882G	25mm x 25m Coil	1pk



Coiled Mustard

**100m Coiled Mustard Pipe**

Order Code	Description
XF864100	16mm x 100m Coil (Mustard only)
XF874100	20mm x 100m Coil (Mustard only)



Pre-Fitted with Conduit

**PEX Pipe – Pre-fitted with Conduit For In-Slab Installation**

Order Code	Description
XF863	16mm x 25m Coil
XF873	20mm x 25m Coil



Pre-Insulated

**Pre-Insulated PEX Pipe**

Order Code	Description
XF862RR3	25m x 16mm Pre-Insulated PEX R0.3 Coil
XF872RR3	25m x 20mm Pre-Insulated PEX R0.3 Coil
XF882RR3	25m x 25mm Pre-Insulated PEX R0.3 Coil
XF862RR8	25m x 16mm Pre-Insulated PEX R0.8 Coil
XF872RR8	25m x 20mm Pre-Insulated PEX R0.8 Coil
XF882RR8	25m x 25mm Pre-Insulated PEX R0.8 Coil

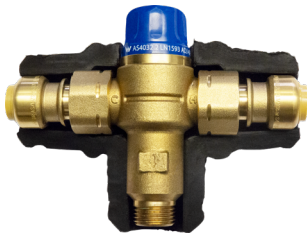

### Tempering Valves PEX Connections

Order Code	Description
MIXSB16	Tempering Valve 16mm*
MIXF11116I	Ultra Solar Tempering Valve 16mm - insulated

\*Also includes SharkBite outlet connection

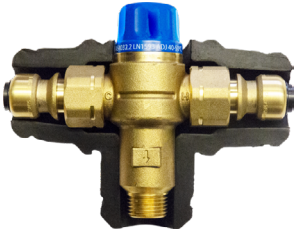

### Tempering Valves Copper Connections

Order Code	Description
MIXRA11009I	Tempering Valve DN15 - insulated
MIXRA11116I	Ultra Solar Tempering Valve DN15 - insulated

MIXRA11009I



### 4 in 1 Tempering Valves – DOWN

Order Code	Description
MIX11014D	Mix 16mm
MIX11013D	Mix 20mm

MIX11014D



### 4 in 1 Tempering Valves – UP

Order Code	Description
MIX11014U	Mix 16mm
MIX11013U	Mix 20mm

MIX11014U

## F1 Conversion Couplings SDR9 PEX – Cu

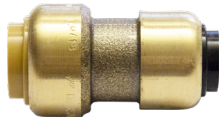

F009X

Order Code	Old Code	Description	Available in
F009X	F009	16mm OD x DN15 Cu	10pk
F017X	F017	20mm OD x DN20 Cu	10pk

## F1 Conversion Couplings SDR9 PEX – SDR7.4 PEX



F009XPX

Order Code	Old Code	Description	Available in
F009XPX	F009PX	16mm SDR9 PEX x 16mm SDR7.4 PEX Coupling	10pk
F017XPX	F017PX	20mm SDR9 PEX x 20mm SDR7.4 PEX Coupling	10pk

## F1 Conversion Couplings SDR9 PEX – PB



F009XPB

Order Code	Old Code	Description	Available in
F009XPB	F009PB	16mm SDR9 PEX x 16mm Polybutylene Coupling	10pk
F017XPB	F017PB	20mm SDR9 PEX x 22mm Polybutylene Coupling	10pk

## F1 Conversion Couplings SDR9 PEX – SDR9 PEX Auspex / Other



F009XAP

Order Code	Old Code	Description	Available in
F009XAP	F009AP	16mm SharkBite to 16mm Auspex Coupling (16mm OD x 16mm SDR9 PEX)	10pk
F017XAP	F017AP	20mm SharkBite to 20mm Auspex Coupling (20mm OD x 20mm SDR9 PEX)	10pk

## F24 Conversion Tee SDR9 PEX – Cu



F363X

Order Code	Old Code	Description	Available in
F363X	F363	16mm OD x 16mm OD x DN15 Cu	5pk
F364X	F364	DN15 Cu x DN 15mm Cu x 16mm OD	5pk
F371X	F371	20mm OD x 20mm OD x DN20 Cu	5pk
F372X	F372	DN20 Cu x DN 20mm Cu x 20mm OD	5pk

## F24 Conversion Tee SDR9 PEX – SDR7.4 PEX



F364XPX

Order Code	Old Code	Description	Available in
F364XPX	F364PX	16mm SDR7.4 PEX x 16mm SDR7.4 PEX x 16mm SharkBite SDR9 PEX Tee	10pk
F372XPX	F372PX	20mm SDR7.4 PEX x 20mm SDR7.4 PEX x 20mm SharkBite SDR9 PEX Tee	10pk



F364XPB

### F24 Conversion Tee SDR9 PEX – PB

Order Code	Old Code	Description	Available in
F641XPB	F364PB	18mm Polybutylene x 18mm Polybutylene x 16mm SharkBite SDR9 PEX Tee	10pk
F372XPB	F372PB	22mm Polybutylene x 22mm Polybutylene x 20mm SharkBite SDR9 PEX Tee	10pk



F250X

### F12 Conversion Elbow SDR9 PEX

Order Code	Old Code	Description	Available in
F250X	F250	16mm SDR9 PEX x 15mm Copper Elbow	10pk
F258X	F258	20mm SDR9 PEX x 20mm Copper Elbow	5pk



F700 & F701

### Tube Cutter

Order Code	Description
F700	PEX Tube Cutter 16mm to 25mm (Ratchet style)
F701	PEX Tube Cutter 16mm to 25mm (Non-Ratchet style)



RA710

### Disassembly Clip

Order Code	Description	Available in
RA710	DN15 Disassembly Clip Cu Only	10pk
F710	16mm Disassembly Clip PEX Only	5pk
F712	20mm Disassembly Clip PEX and Cu	5pk



F702

### Depth Gauge / Deburring Tool

Order Code	Description
F702	DN15 Cu to DN25 Cu



F840

### Tube Bend Support

Order Code	Description	Pack Size
F840	16mm Bend Support	10
F842	20mm Bend Support	5
F844	25mm Bend Support	1



VC875

### Bare Conduit for UV Protection

Order Code	Description
VC875	23mm ID x 25m Coil (Suits 16mm & 20mm PEX)
F707	29mm ID x 25m Coil (Suits 25mm PEX)



F704

**PEX Pipe – Tube Chasing Sleeve**

Order Code	Description
F704	16mm and 20mm x 200m Coil (50mm Sleeve Width)



VC870

**PEX Pipe – RWC Silicone Burial Wrap**

Order Code	Description
VC870	50mm x 3m (Self-adhesive)



UFH034

**Pipe De-Coiler**

Order Code	Description
UFH034	Suits 16mm & 20mm Pipe

\* Pipe not included

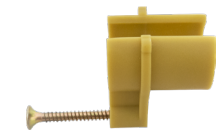

F838

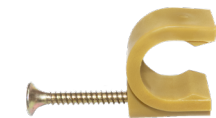

F824



F826



F820

**Tube Clip**

Order Code	Description	Pack Size
F820	16mm Timber	100
F830	20mm Timber	100
F850	25mm Timber	50
F822	16mm Masonry Nail	100
F832	20mm Masonry Nail	100
F852	25mm Masonry Nail	50
F824	16mm Tek Screw	100
F834	20mm Tek Screw	100
F854	25mm Tek Screw	50
F826	16mm Masonry Concrete Anchor	50
F836	20mm Masonry Concrete Anchor	50
F828	16mm Metal Stud	50
F838	20mm Metal Stud	50



F822





-  1800 810 803
-  1800 062 669
-  [sales.au@rwc.com](mailto:sales.au@rwc.com)
-  [sharkbite.com.au](http://sharkbite.com.au)

AN RWC BRAND  Reliance Worldwide Corporation (Aust.) Pty. Ltd.  
27-28 Chapman Place, Eagle Farm QLD 4009,  
Australia | ABN 71 004 784 301

AU-SB-PG0765R1

